

Lamp Type: G36T5VHCA/S07/CB-0N6B

Spec Number:

2845

Engineering Specification Sheet

Lamp Diagram:

Step Base Lamp

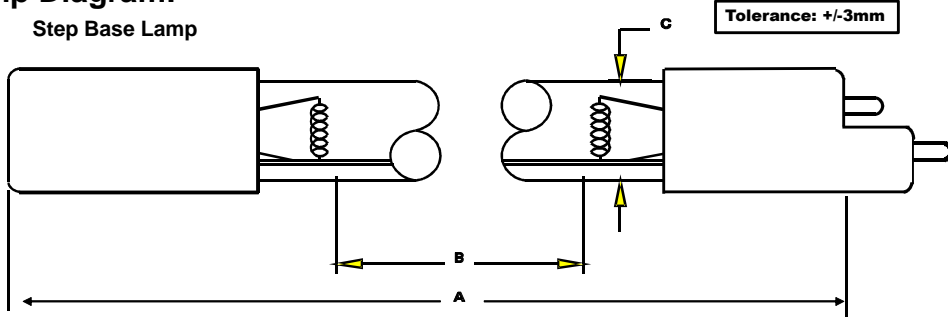

A08-62-C00 HD No Hole Base

Left Base Diagram:

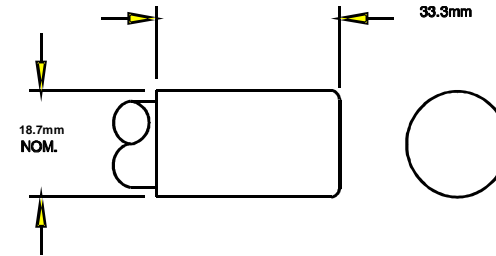

A08-N6-CP0 Step Base

Right Base Diagram:

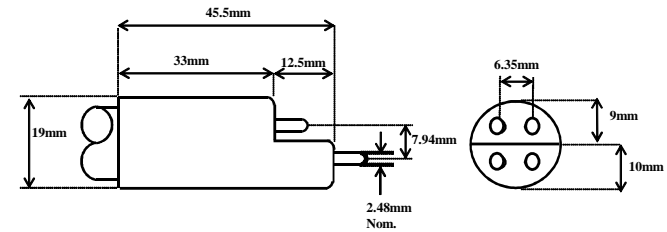

Pin: 08-PN-006

Lamp Characteristics

(A) Base Face:	843	mm		
(B) ARC:	767	mm	Operating Current	420mA
(C) Bulb Diameter	15	mm	Lamp Voltage	120V
(X)			Lamp Wattage	40W
Glass Type:	VH (Ozone)	Coating:	A11-QC-001	
If Spliced:	L	mm	VH	mm
	(Y)			

UV Output - Certified to be true. Kenneth A. Ell, President

Output UVC Watts	micro/watt	/cm ² @ 1 Meter	Rated Life (hrs)	% Output @EOL	Output Notes Field	Ballast Used for Measurements
16		150	12000	80.00%		REI2G64G6MV

First Light
 212 Ideal Way
 Poultney, VT 05764 USA
 Phone-(802) 287-4195 Fax-(802) 287-4489
 www.firstlightusa.com
 email: sales@firstlightusa.com

*UV Output is based on lamps measured after 100 hours of operation under lab conditions. These values are subject to wide variations under application/field conditions.
 UV Output is measured at 254 nm
 **Rated Life is for reference purposes only and is based on a group of lamps operating under lab conditions. Actual life depends on the operating conditions of the lamp.

7/3/2018
 11:21:51 AM

This data includes matters which are trade secrets of First Light Technologies, Inc., or Proprietary or Confidential to First Light Technologies, Inc. and shall not be reproduced or disclosed in whole or part, or used in any manner except in connection with First Light Technologies, Inc. business, without the written permission of First Light Technologies, Inc.