

Lamp Type: GPH508T5LCA/CB-086

Spec Number:

3984

Engineering Specification Sheet

Lamp Diagram:

086 Lam p

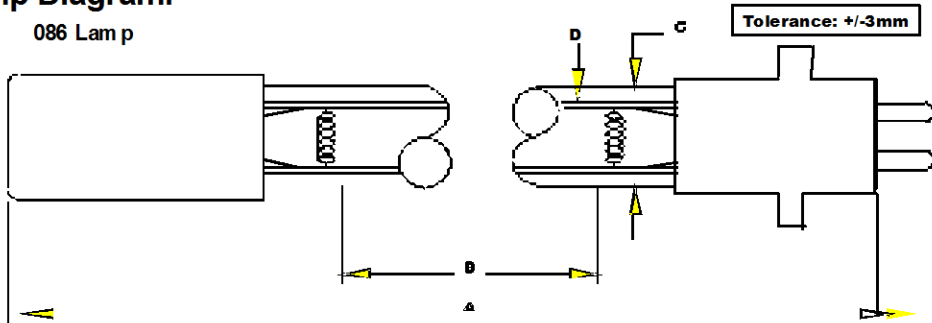

A08-62-C00 HD No Hole Base

Left Base Diagram:

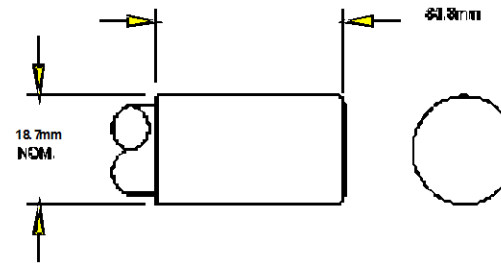

Lamp Characteristics

(A) Base Face:	508	mm	+/- 3		
(B) ARC:	432			Operating Current	420ma.
(C) Bulb Diameter	15			Lamp Voltage	67v
(X)				Lamp Wattage	28w
Glass Type:	L (Non Ozone)	Coating	A11-QC-001		
If Spliced:	L	mm	VH	mm	
	(Y)				



A08-86-CP0 HD RIDGE Base

Right Base Diagram

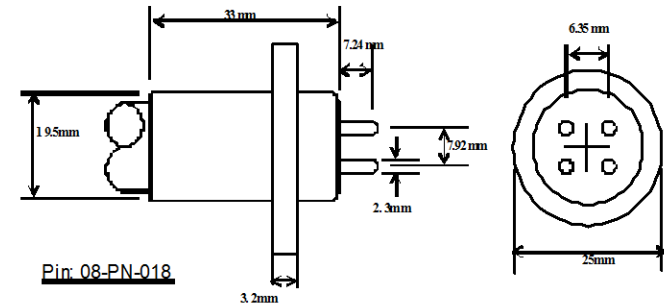

UV Output

Output UVC Watts	Output μ /cm ² @ 1 Meter	Rated Life (hrs)	% Output @EOL	Output Notes Field	Ballast Used for Measurements
9	80	12000	80.00%		SS16550AP



PO Box 191, 212 Ideal Way
 Poultney, VT 05764 USA
 Phone-(802) 287-4195 Fax-(802) 287-4489
 www.firstlightusa.com
 email: sales@firstlightusa.com

*UV Output is based on lamps measured after 100 hours of operation under lab conditions. These values are subject to wide variations under application/field conditions.

3/3/2014

UV Output is measured at 254 nm

9:57:08 AM

**Rated Life is for reference purposes only and is based on a group of lamps operating under lab conditions. Actual life depends on the operating conditions of the lamp.